

MODEL: P24836B75FTB*

BARRIER FREE

*ALL ACCESSORIES OPTIONAL

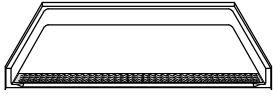

PERSPECTIVE VIEW - N.T.S.

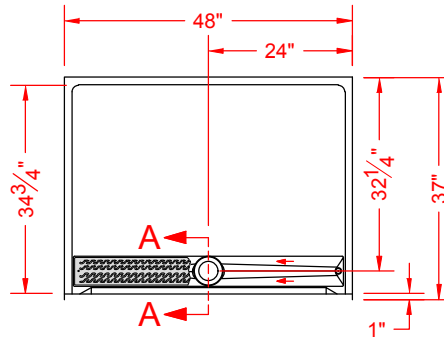

TOP VIEW - SCALE $\frac{3}{8}'' = 1'-0''$

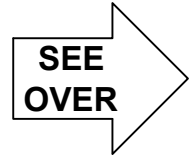

Features:

- Molded, one-piece gelcoat/fiberglass shower pan with trench drain under a stainless steel grate
- Available in various threshold heights
- On all threshold heights 1-1/4" or shorter, no mud set is required and an anchoring adhesive kit is supplied
- On all threshold heights 1-1/2" or taller, no mud set is required

*OTHER THRESHOLD HEIGHTS AVAILABLE UPON REQUEST

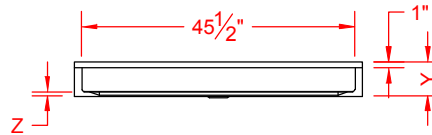

FRONT ELEVATION - SCALE: $\frac{3}{8}'' = 1'-0''$

MODEL #	UNIT HEIGHT	THRESHOLD HEIGHT
P24836B75FTB	Y	Z*
P24836B75FTB	5-3/4"	3/4" MIN
P24836B2FTB	7"	2" MAX

* - SEE BACK FOR DETAIL SECTIONS

PRODUCT SPECIFICATIONS:

- Single-piece shower pan shall be constructed of gelcoat/fiberglass and have a stainless steel drain grate.
- Rough-In: Stud opening + 1/4"-0" Nominal Dimensions.

C.S.I. FORMAT SPECIFICATION TEXT AVAILABLE

PRODUCT INFORMATION:

- Colors: White as standard, others to match any major fixture manufacturer, also available with sprayable solid surface in many colors
- Custom curb heights, other than shown, are available (between min. and max.)

OPTIONAL ACCESSORIES:

- INSTALLED BY OTHERS (INCLUDED):
- Trench grate and no-caulk drain (INCLUDED)

CODES:

- Designed and manufactured in compliance with the following standards and codes:
- A.N.S.I. Z124.2 Standards for Plastic Showers

NOTICE OF LIMITATION:

- Adhere to floor as required
- Does not meet:
 - I.P.C. International Plumbing Code
 - U.P.C. Uniform Plumbing Code



We reserve the right to make revisions without notice in the design of fixtures or in packaging unless this right has specifically been waived at the time the order is accepted.

□ P24836B75FTB

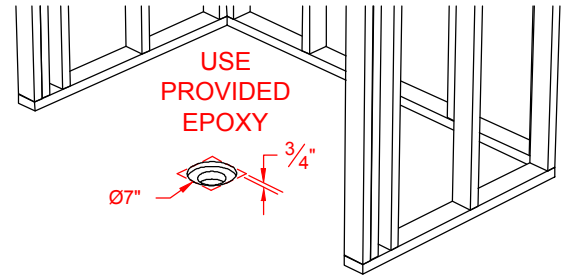
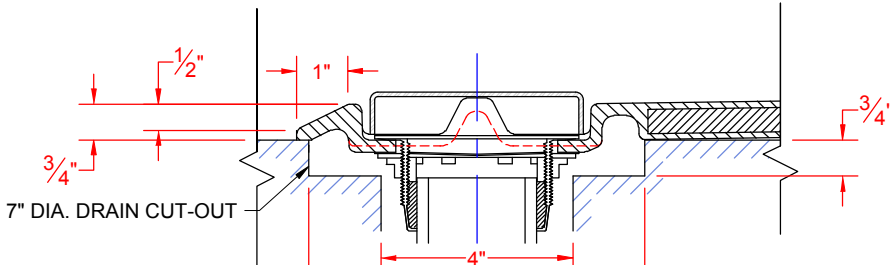

□ P24836B2FTB

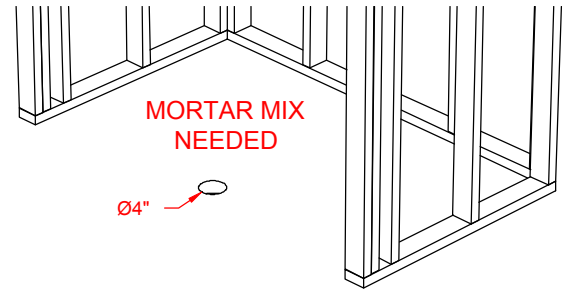
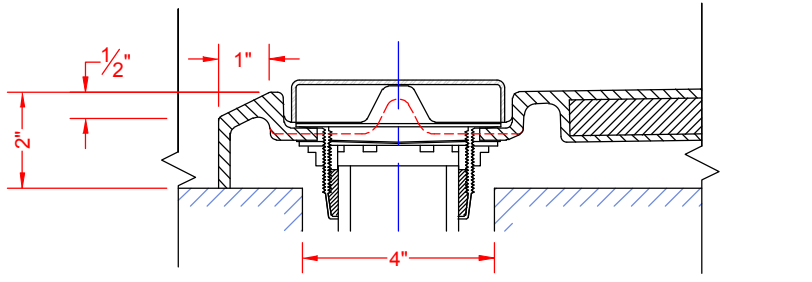

****OTHER THRESHOLD HEIGHTS AVAILABLE UPON REQUEST****